



eco OPTIDRIVE™

AC Variable Speed Drive

HVAC BUILDING SERVICES

Energy efficient fan & pump control



 **BACnet**[®]
MS/TP
built-in as standard

**Low Harmonic
Design**

EN 61000-3-12
Compliant

0.75kW – 250kW / 1HP – 400HP
200–600V Single & 3 Phase Input





Energy Efficient Fan & Pump Control

- AC Induction (IM) Motors
- AC Permanent Magnet (PM) Motors
- Brushless DC (BLDC) Motors
- Synchronous Reluctance (SynRM) Motors

Instant Power Savings

The graph below shows a comparison between the efficiency of various methods which can be used to control the airflow produced by a fan.

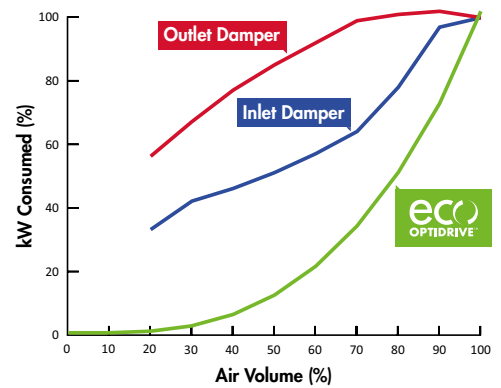

From the data, it can be clearly seen that using methods such as dampers to restrict the airflow is much less efficient than controlling the speed of the fan using an Optidrive Eco HVAC.

Take Control of Your Environment

Modern building ventilation and air conditioning systems are designed to provide optimum climatic conditions for occupants throughout the whole year. As such, they must be designed to operate equally well during the hottest part of the day, with maximum sunlight, through to the colder night time and winter periods. Building designers must take account of these extremes and select components and systems capable of providing the required level of occupant comfort under all conditions. This results in systems operating the majority of the time at less than maximum capacity, which can mean reduced efficiency and wasted energy.

Optidrive Eco HVAC provides a perfect solution to the needs of designers looking to optimise the

performance of fans and pumps used in HVAC applications, allowing them to operate with maximum efficiency under all conditions. Invertek Drives' philosophy to provide innovative products with easy to use, energy efficient features ensures that time, cost and energy savings are maximised at all times, resulting in the shortest possible payback period – the time taken to recover the initial product and installation costs through financial savings achieved through installing Optidrive Eco HVAC drives.

For simple installation into your buildings management system all Optidrive Eco HVAC drives are provided with both BACnet and Modbus RTU as standard across the product range.



IP20



IP55 / NEMA 12



IP66 / NEMA 4X



Energy Savings Calculator

Estimate your potential energy savings, CO₂ emissions and financial savings

www.invertekdrives.com/calculator





Save Energy, Cut CO₂

Save Energy

Accurate speed control of fans and pumps provides the most energy efficient control method

Energy optimisation function minimises energy usage in real time under partial load conditions

Sleep & wake functions ensure operation only when required

Save Money

Advanced on-board features remove the need for peripheral equipment

Intelligent maintenance interval timing allows programmable maintenance reminders, avoiding costly downtime

Automatic load monitoring provides an early warning of potential faults, such as belt failures or blocked filters

Save Time

Built in keypad and OLED text display provides intuitive operation

Simple parameter structure with carefully selected default values reduce commissioning time

Practical design allows easy access to power and control terminals without specialist tools

Key Features



ECO Vector Motor Control



Standard Induction Motors



Permanent Magnet AC Motors

Brushless DC Motors

Synchronous Reluctance Motors

Energy Optimised Design



Internal EMC Filter



Low Noise Operation



Improved Fan Efficiency

Unique Eco Vector Sensorless Control

Optidrive Eco HVAC uses advanced motor control, designed to provide the most energy efficient motor control possible. Operation with standard IM Motors, Permanent Magnet or Synchronous Reluctance motors is possible, all without requiring any feedback device or optional modules – simply change parameters to suit the connected motor, autotune and operate!

Eco Vector continuously adjusts in real time to provide the most efficient operating conditions for the load, typically reducing energy consumption by 2 – 3% compared to standard AC drives – providing similar long term costs savings to selecting a higher efficiency motor.

Energy Optimised Design

Optidrive Eco HVAC up to frame size 5 are designed with film capacitors, replacing the traditional electrolytic capacitors used in the DC link. Film capacitors have lower losses, and also remove the need for AC, DC or swinging chokes, improving overall drive efficiency. Efficiency is improved by up to 4% compared to standard AC drives, whilst also reducing supply current total harmonic distortion (iTHD), improving the Real Power Factor and reducing total input current, leading to cost savings on installation through reduced cable and fuse ratings and smaller supply transformer rating.

Improved Efficiency, Reduced Lifetime Costs: e.g. for a 37kW load, operating 10 hours per day, 5 days per week, 50 weeks per year, improving the efficiency by just 1% will provide an energy saving > 900kWh per year.

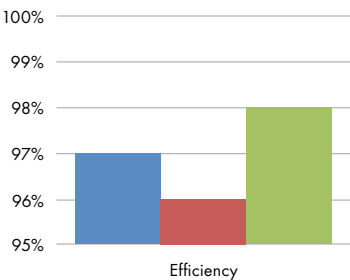

Typical efficiency comparison for Optidrive Eco HVAC vs other AC variable speed drives

Standard AC Variable Speed Drive
AC Variable Speed Drive + 4% Line Choke
Optidrive Eco HVAC

Dedicated to HVAC Applications

Take control of your environment

Stairwell Pressurisation

Energy Efficient Air Handling

Fire Override

Chiller Pump Control

Fume Extraction

Building Comfort

Energy Efficient Air Handling

Creating comfortable building environments without high energy costs

Where do the energy savings come from?

Air conditioning can use a significant amount of energy. In some cases it could even double energy consumption, not to mention the resultant increase in a company's carbon footprint.

Don't produce more airflow than you need!

Typically the air conditioning systems in buildings are designed for maximum occupancy and peak outside ambient. This means that for the majority of time there is large scope for running the systems at reduced speed and significant money to be saved with variable speed drives.

Optidrive Eco HVAC can vary the output of your air conditioning system to meet the varying demands throughout the day.

Variable Speed Control for Pumps

Optidrive Eco HVAC provides the ideal pump control solution for chiller, circulation and cooling pumps.



Energy efficient control for HVAC systems

Airports
Hotels
Conference Centres
Shopping Centres
Hospitals
Kitchens
Schools
Offices
Laboratories

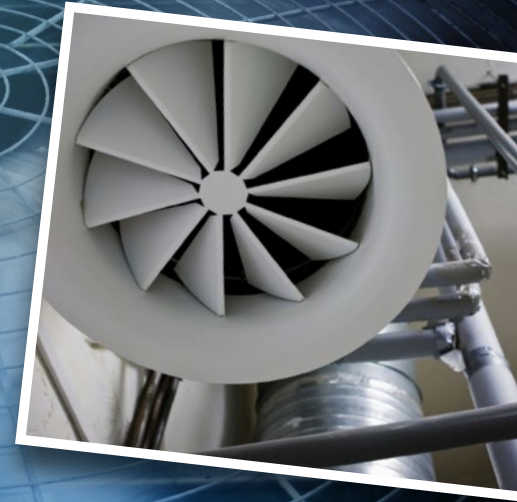

Building Safety Systems

Stairwell Pressurisation

Stairwell (escape route) pressurisation systems are being extensively employed in large buildings and complexes to help ensure the safe evacuation of occupants during a fire. Variable speed drives are playing an increasing role in maintaining pressures (of approximately 50 Pa) within these critical areas. Here Optidrive Eco HVAC is used to provide a smoke free escape by accurately maintaining the air pressure along that route.

Pressures must be maintained at a high enough level that a door opened between the fire floor and the escape route does not result in smoke entering the escape route. Equally, as doors and vents are opened along the escape route allowing air to escape the Optidrive and stairwell pressurisation system must increase output so that the required pressure is accurately maintained.

Fume Extraction

Many buildings now incorporate dedicated smoke management and extraction systems designed to safely extract smoke in the event of a fire, these systems are designed to localise and extract smoke such that the rest of the building remains smoke free and can be evacuated safely. Here the Optidrive's Fire Mode function is critical in maintaining continued operation of the smoke extraction system for the longest permissible period.

For applications such as underground car parks the fans providing fresh air intake are often reversed in the event of a fire to provide smoke extraction. Optidrive Eco HVAC is easily configured for bi-directional fire mode operation.

Fire Override



Fire override mode ignores signals and alarms, keeping the Optidrive Eco HVAC operating for as long as possible.

- This feature is crucial for ensuring smoke extraction from buildings in the event of a fire.
- Selectable logic means that the Optidrive Eco HVAC can be easily configured to the signal produced by your fire management system.
- With an independently set speed for fire mode operation, selectable as either forward or reverse direction, the Optidrive Eco HVAC has the flexibility to match the needs of your fire control system.
- Fire mode operation is indicated clearly on the drive display during periods of fire mode operation.
- Drive output logic can easily be configurable for indicating to external drives that fire mode is active.
- Internal clocks and timers monitoring operation in fire mode, giving clear information on usage.

Drive Features

A compact and robust range of drives dedicated to HVAC



Internal EMC Filter

Compliant with global EMC Standards

Maintenance interval timer and service indication

Multi Language Text Display



Hand / Auto Keypad



Pluggable terminals



Integrated cable management



IP66 with optional mains disconnect



Multi Language Text Display

Installed as standard on all IP55 & IP66 models

- Clear multi-line text display
- Operates -10 to 50°C
- Wide viewing angle, effective in dark and light conditions
- Customisable display
- Multi-language selection

Belt Break Detection



Optidrive Eco HVAC can provide immediate warning of broken belt between motor and fan. Due to its simple and flexible configuration the feature can also be used for any loss of load condition, such as broken coupling or other mechanical failure.

Optidrive Eco HVAC monitors the load output profile throughout the speed range and compares it to normal operating conditions (established during commissioning). Sensitivity adjustment means that it is possible to detect the indications of a belt failure (such as belt slipping) prior to complete failure of the belt.

Drive Controlled Bypass

Optidrive Eco HVAC can operate as a bypass controller when installed as part of a bypass circuit. Activation of Bypass mode can be determined intelligently by the Optidrive Eco HVAC drive based on a command from the building management system. Additionally the drive can be set to automatically select bypass mode when entering into a trip condition ensuring minimal disruption to service.



Energy efficient control for HVAC systems

Hand / Auto

Allows manual control to easily be selected in the event of an automatic control system failure or for simplified commissioning / system checks, or when a fast temporary override of the control system is required. Built-in 'Auto Control Selection' allows return to automatic system control just as easily.



Noise Reduction

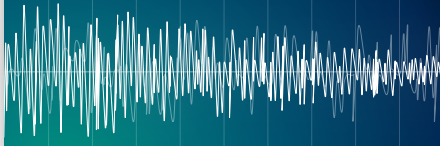

Quiet Motor Operation

High switching frequency selection (up to 32kHz) ensures motor noise is minimised.

Quiet System Mechanics

Simple skip frequency selection avoids stresses and noise caused by mechanical resonance in ducting or pipework.

Quiet Drive Operation

Long Life Dual Ball Bearing Fans provide quiet operation in addition to extended fan life.

Noise Reduction through Speed Control

Optimising motor speed gives significant energy savings and reduces motor noise.

Reduced Harmonic Current Distortion

Optidrive Eco HVAC uses innovative design to improve overall efficiency whilst minimising the harmonic distortion levels. All drives designed for 3 phase power supply operation¹ up to frame size 5 utilise film capacitor in the DC link, providing exceptionally low harmonic current distortion without compromising efficiency. Frame size 6 and above include DC chokes and traditional electrolytic capacitors.

Optidrive Eco HVAC product range complies with the requirements of EN61000-3-12.

Typical iTHD values at full and part load

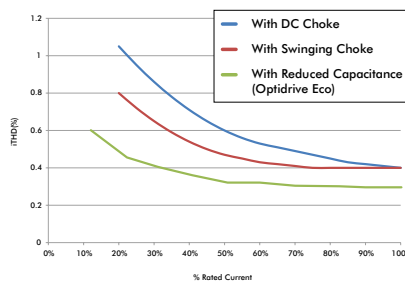

It can be clearly seen that the reduced DC link capacitance significantly reduces the total harmonic distortion at full load, and has a much greater benefit at part load compared to a conventional DC choke or swinging choke. This results in reduced overall input current and reduced transformer heating effect.

Optidrive Eco HVAC delivers

- Improved Efficiency, Reduced Lifetime Costs: e.g. for a 37kW load, operating 10 hours per day, 5 days per week, 50 weeks per year, improving the efficiency by just 1% will provide an energy saving > 900kWh per year
- Improved True Power Factor – No additional charges etc.
- Lower Mains Supply Current

Power factor comparison

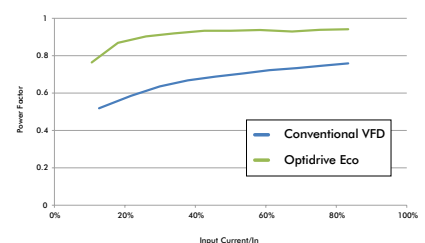

Optidrive Eco offers improved power factor over conventional VFDs under all loads.

¹ 200V and 400V

Options & Accessories

Peripherals to help integrate Optidrive Eco HVAC with your HVAC systems



Optistick Smart



Bluetooth®

Rapid Commissioning Tool

- Allows copying, backup and restore of drive parameters
- Provides Bluetooth interface to a PC running OptiTools Studio or the OptiTools Mobile app on a smartphone
- Onboard NFC (Near Field Communication) for rapid data transfer

OPT-3-STICK-IN

Optipad



Remote Keypad & TFT Display

IP55 panel mount operator interface.

- Clear multi-line text display
- Multiple language select
- Customisable displays

OPT-3-OPPAD-IN





Energy efficient control for HVAC systems

OptiTools Studio

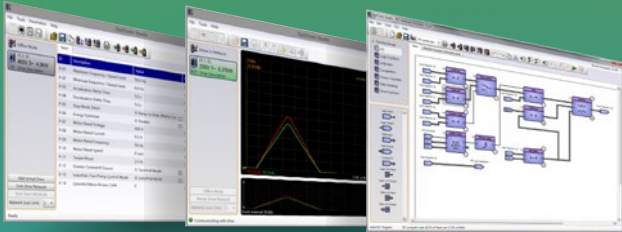

Powerful PC Software

Drive commissioning and parameter backup

- Real-time parameter editing
- Drive network communication
- Parameter upload, download and storage
- Simple PLC function programming
- Real-time scope function and data logging
- Real-time data monitoring

Compatible with:

- Windows Vista
- Windows 7
- Windows 8
- Windows 8.1
- Windows 10

Fieldbus Interfaces



BACnet/IP
OPT-2-BNTIP-IN



PROFIBUS DP
OPT-2-PROFB-IN



DeviceNet
OPT-2-DEVNT-IN



EtherNet/IP
OPT-2-ETHNT-IN



Modbus TCP
OPT-2-MODIP-IN



PROFINET
OPT-2-PFNET-IN



EtherCAT
OPT-2-ETCAT-IN



Plug-in Options



Extended I/O
OPT-2-EXTIO-IN

- Additional 3 Digital Inputs
- Additional Relay Output

Cascade Control
OPT-2-CASCD-IN

Additional 3 Relay Outputs

BACnet MS/TP & Modbus RTU on board as standard

Mains Isolator



Mains Isolator Option

Frame Sizes 2 & 3 can be factory ordered with a built in lockable isolator. An optional bolt on isolator is available for Frame Sizes 4 & 5.

Product Codes:
Frame Size 4 = OPT-2-ISOL4-IN
Frame Size 5 = OPT-2-ISOL5-IN

Replace # in model code with enclosure/display option

	kW	HP	Amps	Frame Size	Model Code							IP20 Cabinet Mount	IP55 TFT Display	Indoor IP66 Non Switched	Indoor IP66 with Disconnect	Outdoor IP66 Non Switched	Outdoor IP66 with Disconnect	
					Product Family	Generation	Frame Size	Voltage Code	Output Rating	Supply Phases	EMC Filter							Capacitor
200-240V ± 10% 1 Phase Input	0.75	1	4.3	2	ODV	-3	-2	2	0043	-1	F	1	#	2-MN	X-TN	D-TN	A-MN	E-MN
	1.5	2	7	2	ODV	-3	-2	2	0070	-1	F	1	#	2-MN	X-TN	D-TN	A-MN	E-MN
	2.2	3	10.5	2	ODV	-3	-2	2	0105	-1	F	1	#	2-MN	X-TN	D-TN	A-MN	E-MN
200-240V ± 10% 3 Phase Input	0.75	1	4.3	2	ODV	-3	-2	2	0043	-3	F	1	#	2-MN	X-TN	D-TN	A-MN	E-MN
	1.5	2	7	2	ODV	-3	-2	2	0070	-3	F	1	#	2-MN	X-TN	D-TN	A-MN	E-MN
	2.2	3	10.5	2	ODV	-3	-2	2	0105	-3	F	1	#	2-MN	X-TN	D-TN	A-MN	E-MN
	4	5	18	3	ODV	-3	-3	2	0180	-3	F	1	#	2-MN	X-TN	D-TN	A-MN	E-MN
	5.5	7.5	24	3	ODV	-3	-3	2	0240	-3	F	1	#	2-MN	X-TN	D-TN	A-MN	E-MN
	7.5	10	30	3	ODV	-3	-3	2	0300	-3	F	1	#	2-MN	X-TN	D-TN	A-MN	E-MN
	7.5	10	30	4	ODV	-3	-4	2	0300	-3	F	1	#	2-MN	N-MN			
	11	15	46	4	ODV	-3	-4	2	0460	-3	F	1	#	2-MN	N-MN		A-MN	E-MN
	15	20	61	5	ODV	-3	-5	2	0610	-3	F	1	#	2-MN	N-MN			
	18.5	25	72	5	ODV	-3	-5	2	0720	-3	F	1	#	2-MN	N-MN			
	22	30	90	5	ODV	-3	-5	2	0900	-3	F	1	#	2-MN	N-MN			
	30	40	110	6	ODV	-3	-6	2	1100	-3	F	1	#	2-MN	N-MN			
	30	40	110	6A	ODV	-3	-6	2	1100	-3	F	1	#	2-MN				
	37	50	150	6	ODV	-3	-6	2	1500	-3	F	1	#	2-MN	N-MN			
	37	50	150	6A	ODV	-3	-6	2	1500	-3	F	1	#	2-MN				
	45	60	180	6	ODV	-3	-6	2	1800	-3	F	1	#	2-MN	N-MN			
	45	60	180	6B	ODV	-3	-6	2	1800	-3	F	1	#	2-MN				
	55	75	202	7	ODV	-3	-7	2	2020	-3	F	1	#	2-MN	N-MN			
75	100	248	7	ODV	-3	-7	2	2480	-3	F	1	#	2-MN	N-MN				
380-480V ± 10% 3 Phase Input	0.75	1	2.2	2	ODV	-3	-2	4	0022	-3	F	1	#	2-MN	X-TN	D-TN	A-MN	E-MN
	1.5	2	4.1	2	ODV	-3	-2	4	0041	-3	F	1	#	2-MN	X-TN	D-TN	A-MN	E-MN
	2.2	3	5.8	2	ODV	-3	-2	4	0058	-3	F	1	#	2-MN	X-TN	D-TN	A-MN	E-MN
	4	5	9.5	2	ODV	-3	-2	4	0095	-3	F	1	#	2-MN	X-TN	D-TN	A-MN	E-MN
	5.5	7.5	14	2	ODV	-3	-2	4	0140	-3	F	1	#	2-MN			A-MN	E-MN
	5.5	7.5	14	3	ODV	-3	-3	4	0140	-3	F	1	#	2-MN	X-TN	D-TN		
	7.5	10	18	3	ODV	-3	-3	4	0180	-3	F	1	#	2-MN	X-TN	D-TN	A-MN	E-MN
	11	15	24	3	ODV	-3	-3	4	0240	-3	F	1	#	2-MN	X-TN	D-TN	A-MN	E-MN
	15	20	30	3	ODV	-3	-3	4	0300	-3	F	1	#	2-MN			A-MN	E-MN
	15	20	30	4	ODV	-3	-4	4	0300	-3	F	1	#	2-MN	N-MN			
	18.5	25	39	4	ODV	-3	-4	4	0390	-3	F	1	#	2-MN	N-MN		A-MN	E-MN
	22	30	46	4	ODV	-3	-4	4	0460	-3	F	1	#	2-MN	N-MN		A-MN	E-MN
	30	40	61	5	ODV	-3	-5	4	0610	-3	F	1	#	2-MN	N-MN			
	37	50	72	5	ODV	-3	-5	4	0720	-3	F	1	#	2-MN	N-MN			
	45	60	90	5	ODV	-3	-5	4	0900	-3	F	1	#	2-MN	N-MN			
	55	75	110	6	ODV	-3	-6	4	1100	-3	F	1	#	2-MN	N-MN			
	55	75	110	6A	ODV	-3	-6	4	1100	-3	F	1	#	2-MN				
	75	100	150	6	ODV	-3	-6	4	1500	-3	F	1	#	2-MN	N-MN			
	75	100	150	6A	ODV	-3	-6	4	1500	-3	F	1	#	2-MN				
	90	150	180	6	ODV	-3	-6	4	1800	-3	F	1	#	2-MN	N-MN			
90	150	180	6B	ODV	-3	-6	4	1800	-3	F	1	#	2-MN					
110	175	202	6B	ODV	-3	-6	4	2020	-3	F	1	#	2-MN					
110	175	202	7	ODV	-3	-7	4	2020	-3	F	1	#	2-MN	N-MN				
132	200	240	7	ODV	-3	-7	4	2400	-3	F	1	#	2-MN	N-MN				
160	250	302	7	ODV	-3	-7	4	3020	-3	F	1	#	2-MN	N-MN				
200	300	370	8	ODV	-3	-8	4	3700	-3	#	1	#	2-MN	N-MN				
250	350	480	8	ODV	-3	-8	4	4500	-3	#	1	#	2-MN	N-MN				
500-600V ± 10% 3 Phase Input	0.75	1	2.1	2	ODV	-3	-2	6	0021	-3	0	1	#	2-MN	X-TN	D-TN	A-MN	E-MN
	1.5	2	3.1	2	ODV	-3	-2	6	0031	-3	0	1	#	2-MN	X-TN	D-TN	A-MN	E-MN
	2.2	3	4.1	2	ODV	-3	-2	6	0041	-3	0	1	#	2-MN	X-TN	D-TN	A-MN	E-MN
	4	5	6.5	2	ODV	-3	-2	6	0065	-3	0	1	#	2-MN	X-TN	D-TN	A-MN	E-MN
	5.5	7.5	9	2	ODV	-3	-2	6	0090	-3	0	1	#	2-MN	X-TN	D-TN	A-MN	E-MN
	7.5	10	12	3	ODV	-3	-3	6	0120	-3	0	1	#	2-MN	X-TN	D-TN	A-MN	E-MN
	11	15	17	3	ODV	-3	-3	6	0170	-3	0	1	#	2-MN	X-TN	D-TN	A-MN	E-MN
	15	20	22	3	ODV	-3	-3	6	0220	-3	0	1	#	2-MN			A-MN	E-MN
	15	20	22	4	ODV	-3	-4	6	0220	-3	0	1	#	2-MN	N-MN			
	18.5	25	28	4	ODV	-3	-4	6	0280	-3	0	1	#	2-MN	N-MN		A-MN	E-MN
	22	30	34	4	ODV	-3	-4	6	0340	-3	0	1	#	2-MN	N-MN		A-MN	E-MN
	30	40	43	4	ODV	-3	-4	6	0430	-3	0	1	#	2-MN	N-MN		A-MN	E-MN
	37	50	54	5	ODV	-3	-5	6	0540	-3	0	1	#	2-MN	N-MN			
	45	60	65	5	ODV	-3	-5	6	0650	-3	0	1	#	2-MN	N-MN			
	55	75	78	6	ODV	-3	-6	6	0780	-3	0	1	#	2-MN	N-MN			
	75	100	105	6	ODV	-3	-6	6	1050	-3	0	1	#	2-MN	N-MN			
	90	125	130	6	ODV	-3	-6	6	1300	-3	0	1	#	2-MN	N-MN			
	110	150	150	6	ODV	-3	-6	6	1500	-3	0	1	#	2-MN	N-MN			

EMC Filter

- 0** No Internal EMC Filter
- F** Internal EMC Filter
- R** High Performance EMC Filter

Drive Specification

Input Ratings	Supply Voltage	200 – 240V ± 10% 380 – 480V ± 10% 500 – 600V ± 10%
	Supply Frequency	48 – 62Hz
	Displacement Power Factor	> 0.98
	Phase Imbalance	3% Maximum allowed
	Inrush Current	< rated current
	Power Cycles	120 per hour maximum, evenly spaced
	Output Ratings	Output Power
Overload Capacity		110% for 60 seconds 165% for 4 seconds
Output Frequency		0 – 250Hz, 0.1Hz resolution
Typical Efficiency		> 98%
Ambient Conditions		Temperature: Storage: –40 to 60°C Operating: –10 to 50°C Altitude: Up to 1000m ASL without derating Up to 2000m maximum UL approved Up to 4000m maximum (non UL) Humidity: 95% Max, non condensing Vibration: Conforms to EN61800-5-1 2007, IEC 60068-2-6
Enclosure	Ingress Protection	IP20, IP55, IP66
	Programming	Keypad: Built-in keypad as standard Optional remote mountable keypad Display: Built-in multi language text display PC: OptiTools Studio
Control Specification	Control Method	Eco Sensorless Vector Open Loop Permanent Magnet Vector Open Loop BLDC Vector Open Loop Synchronous Reluctance Vector
	PWM Frequency	4 – 32kHz Effective
	Stopping Mode	Ramp to stop: User Adjustable 0.1–600 secs Coast to stop
	Braking	AC Flux Braking
	Skip Frequency	Single point, user adjustable
Setpoint Control	Analog Signal	0 to 10 Volts / 10 to 0 Volts –10 Volts to +10 Volts 0 to 20mA / 20 to 0mA 4 to 20mA / 20 to 4mA
	Digital	Motorised Potentiometer (Keypad) Modbus RTU BACnet MS/TP
Fieldbus Connectivity	Built-in	BACnet Application Specific Controller 9.6 - 76.8 kbps selectable Data Format: 8N1, 8N2, 8O1, 8E1
		Modbus RTU 9.6 - 115.2 kbps selectable Data Format: 8N1, 8N2, 8O1, 8E1
	Optional	BACnet/IP Plug-in BACnet/IP interface Dual LAN ports Device Level Ring Other: PROFIBUS DP (DPV1) PROFINET IO DeviceNet EtherNet/IP EtherCAT Modbus TCP

I/O Specification	Power Supply	24 Volt DC, 100mA, Short Circuit Protected 10 Volt DC, 10mA for Potentiometer	
	Programmable Inputs	5 Total as standard (optional additional 3) 3 Digital (optional additional 3) 2 Analog / Digital selectable	
	Digital Inputs	Opto - Isolated 8 – 30 Volt DC, internal or external supply Response time < 4ms	
	Analog Inputs	Resolution: 12 bits Response time: < 4ms Accuracy: < 1% full scale Parameter adjustable scaling and offset	
	PTC Input	Motor PTC / Thermistor Input Trip Level : 3kΩ	
	Programmable Outputs	2 Total 1 Analog / Digital 1 Relay	
	Relay Outputs	Maximum Voltage: 250 VAC, 30 VDC Switching Current Capacity: 5A	
	Analog Outputs	0 to 10 Volts / 10 to 0 Volts 0 to 20mA / 20 to 0mA 4 to 20mA / 20 to 4mA	
	Application Features	PID Control	Internal PID Controller Multi-setpoint Select Standby / Sleep Mode Boost Function
		Fire Mode	Bidirectional Selectable Speed Setpoint (Fixed / PID / Analog / Fieldbus)
Load Monitoring		High Current Protection (Fan / Bump Blocked) Low Current Protection (Broken Belt / Shaft) Pump Blockage Detection with Cleaning	
Duty / Assist / Standby		Built-in Multi-Pump Support Automatic Changeover on Fault Automatic Changeover on Time Fully Redundant	
Pump Control Features		Pump Blockage Detection: Pump load monitoring with autotune function, user configurable Pump Cleaning: Adjustable Bi-directional Pump Cleaning Cycle operation Multi-Pump Control: Control of fixed speed assist pumps (with cascade control module) Control of Duty, Assist and Standby variable speed pumps via internal Master – Slave network Pump Stir: Automatic pump stir to prevent sediment build-up	
Maintenance & Diagnostics	Fault Memory	Last 4 Trips stored with time stamp	
	Data Logging	Logging of data prior to trip for diagnostic purposes: Output Current Drive Temperature DC Bus Voltage	
	Maintenance Indicator	Maintenance Indicator with user adjustable maintenance interval Onboard service life monitoring	
	Monitoring	Hours Run Meter Resettable & Non-Resettable kWh meters Cooling Fan Run Time	
Standards Compliance	Low Voltage Directive	2014/35/EU	
	EMC Directive	2014/30/EU	
	Additional Conformance	UL, cUL, EAC, RCM	
	Harmonic Currents	IEC61000-3-12	
Environmental Conditions	Designed to meet IEC 60721-3-3, in operation: IP20 Drives: 3S2/3C2 IP55 & 66 Drives: 3S3/3C3		

Model Code Guide

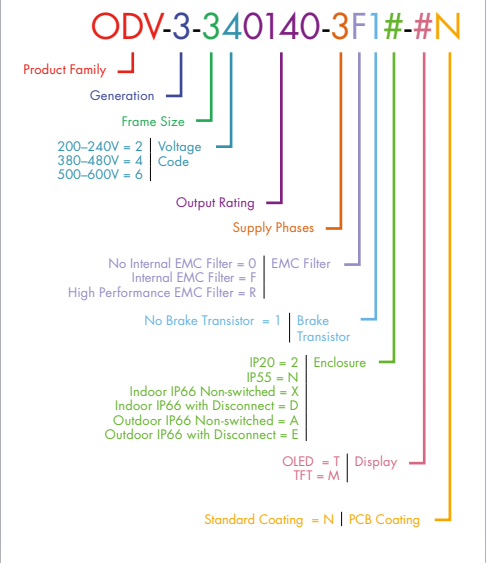

Connection Diagram

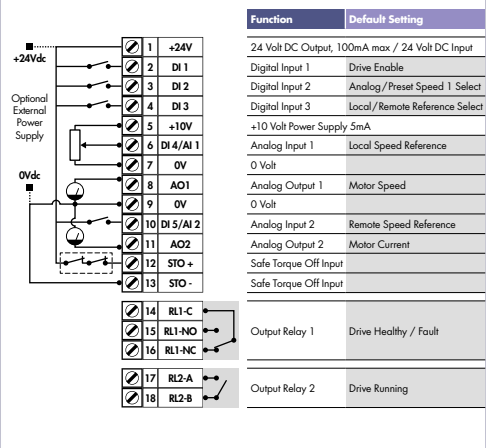

NOT TO SCALE

Size	IP20						IP66			IP55					
	2	3	4	5	6A	6B	8	2	3	4	4	5	6	7	8
mm Height	221	261	418	486	614	726	974	257	310	360	450	540	865	1280	1334
mm Width	110	131	172	233	286	330	444	188	211	240	171	235	330	330	444
mm Depth	185	205	240	260	320	320	423	182	235	271	252	270	332	358	423
kg Weight	1.8	3.5	9.2	18.1	32	43	124.5	3.5	6.6	9.5	11.5	23	55	89	TBC

Optidrive Eco HVAC

✓ Saving Energy / Reducing CO₂

With large scale increases in global energy costs and the introduction of taxes and legislation relating to the industrial production of CO₂ gases the need to reduce energy consumption and save money has never been greater. Optidrive Eco HVAC can be used with environmental sensors to reduce speed in air handling and pumping applications without compromising the required output of the system.

✓ Easy Installation

Compact and modern design utilising the latest available technology has accumulated in a robust HVAC drive with small dimensions and innovative mounting and cabling features.

✓ Simple Set-up & Rapid Commissioning

Optidrive Eco HVAC was developed from concept for ease of use. A handful of parameters configure the drive for basic HVAC applications. A short, concise product data means the drive is running in seconds. Advanced powerful functionality is equally easily accessible.

✓ Imaginative Enclosure Design

With a selection of IP55 and IP66 enclosures, Optidrive Eco HVAC is well suited to harsh environments, or where cabinet and cabling costs need to be reduced.

✓ Advanced Fan Control Functions

The key HVAC control functionality required for your application is inbuilt into the Optidrive Eco HVAC and packaged to be both quick and simple to activate. Added to this is the drive's own PLC programming flexibility that makes drive functionality virtually limitless.

✓ Options for Flexibility

Optidrive Eco HVAC combines both peripheral and factory built options to ensure you get the right drive, scaled to suit your application. With inbuilt BACnet and Modbus, and a host of communication options the Optidrive can integrate easily into your industrial network of choice.



UK Headquarters, Welshpool

Invertek Drives Ltd is dedicated to the design, manufacture and marketing of electronic variable speed drives. The state of the art UK headquarters houses specialist facilities for research & development, manufacturing and global marketing. The company pledges to implement and operate the ISO 14001 Environmental Management System to enhance environmental performance.

All company operations are accredited to the exacting customer focused ISO 9001:2008 quality standard. The company's products are sold globally in over 80 different countries. Invertek Drives' unique and innovative drives are designed for ease of use and meet with recognised international design standards.

Global HVAC Solutions

Invertek Drives operate at the heart of HVAC systems around the world

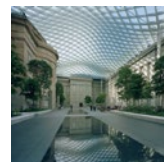

USA

National Portrait Gallery climate control



UK

Saving energy in ventilation and boilers

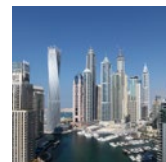

DUBAI

Saving energy in air conditioning systems



SINGAPORE

Energy saving & noise reduction programme



www.invertekdrives.com/hvac-building-services

INVERTEK DRIVES LIMITED UK Headquarters

Offa's Dyke Business Park
Welshpool, Powys, UK
SY21 8JF

Tel: +44 (0)1938 556868
Fax: +44 (0)1938 556869
Email: sales@invertekdrives.com

