



eco
OPTIDRIVE™

AC Variable Speed Drive

PUMP CONTROL

Energy efficient pumping with **OPTIFLOW™**



 **BACnet®**
MS/TP
built-in as standard

**Low Harmonic
Design**
EN 61000-3-12
Compliant

0.75kW – 250kW / 1HP – 400HP
200–600V Single & 3 Phase Input



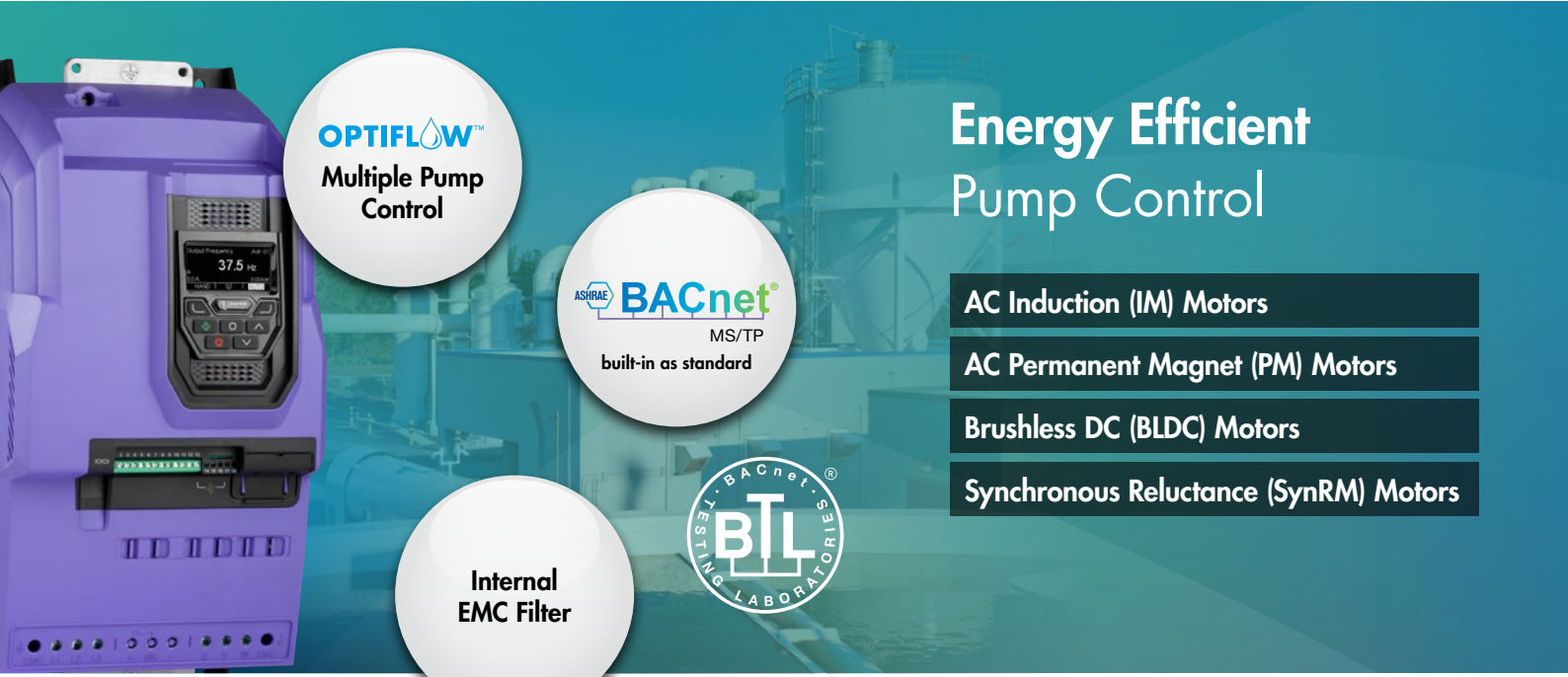

Energy Efficient Pumping

When a pump or pump set is selected, it must be suitable for operation during periods of maximum flow demand. In many applications, this maximum flow level may be rarely required, and as such the pump may operate for long periods at less than maximum flow capacity. By varying the speed of the pump to match the actual flow demand, significant energy savings are possible.

Optidrive Eco Pump has been designed to maximise the energy savings potential in pumping applications, whilst also providing significant additional benefits

in reduced installation costs, maintenance costs and downtime. Throughout all this, Invertek's "Ease of Use" philosophy ensures that advanced features are simple to commission, without requiring extensive, in depth knowledge of a huge number of parameters. Optidrive Eco Pump has a simple menu structure, and provides just the right amount of parameters to allow flexibility without over complication.

Overall, this provides the perfect balance of Easy to Install, Easy to operate, Advanced Pump Control.



IP20



IP55 / NEMA 12



IP66 / NEMA 4X



Energy Savings Calculator

Estimate your potential energy savings, CO₂ emissions and financial savings

www.invertekdrives.com/calculator





Save Energy

Eco vector operation, based on Invertek's advanced motor control provides the most energy efficient operation of the pump, continually optimising the output to match the required flow with minimum energy consumption.

Advanced sleep & wake functions provide maximum energy savings by switching off the pump when not required

Save Money

OPTIFLOW™ technology allows simple operation of multiple pump sets without the need for a PLC

Pump blockage detection and cleaning dramatically reduces pump maintenance requirements

Built in PLC function allows bespoke customised applications to be programmed directly in the drive

Save Time

Simple parameter set allows fast commissioning of pump control systems

Pump operating curve detection automatically detects and monitors normal pump behaviour and is able to react when pumping conditions change

Customisable OLED display provides excellent visibility of drive status and operation in all conditions

Key Features



ECO Vector Motor Control



Standard Induction Motors



Permanent Magnet AC Motors

Brushless DC Motors

Synchronous Reluctance Motors

Energy Optimised Design



Internal EMC Filter



Low Noise Operation



Maximum Pumping Efficiency

Unique Eco Vector Sensorless Control

Optidrive Eco Pump uses advanced motor control technology, designed to provide the most energy efficient motor control possible. Operation with standard IM Motors, Permanent Magnet or Synchronous Reluctance motors is possible, all without requiring any feedback device or optional modules – simply change parameters to suit the connected motor, autotune and operate!

Eco Vector continuously adjusts in real time to provide the most efficient operating conditions for the load, typically reducing energy consumption by 2 – 3% compared to standard AC drives – providing similar long term costs savings to selecting a higher efficiency motor.

Energy Optimised Design

Optidrive Eco Pump up to frame size 5 are designed with film capacitors, replacing the traditional electrolytic capacitors used in the DC link. Film capacitors have lower losses, and also remove the need for AC, DC or swinging chokes, improving overall drive efficiency. Efficiency is improved by up to 4% compared to standard AC drives, whilst also reducing supply current total harmonic distortion (iTHD), improving the Real Power Factor and reducing total input current, leading to cost savings on installation through reduced cable and fuse ratings and smaller supply transformer rating.

Improved Efficiency, Reduced Lifetime Costs: e.g. for a 37kW load, operating 10 hours per day, 5 days per week, 50 weeks per year, improving the efficiency by just 1% will provide an energy saving > 900kWh per year.

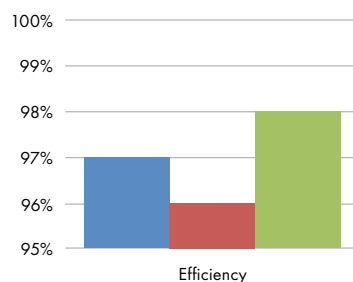

Typical efficiency comparison for Optidrive Eco Pump vs other AC variable speed drives

■ Standard AC Variable Speed Drive
■ AC Variable Speed Drive + 4% Line Choke
■ Optidrive Eco Pump

OPTIFLOW™ Multi-pump Control

Embedded control technology for multi-pump systems

Flexible pump station control with no PLCs or pump control units

Setpoint Control

A standard
feature on
all drives

Pump Prime Mode



Pump Prime with Burst Pipe
Detection

Pump prime mode allows starting of the pump in a safely controlled manner, to ensure consistent filling and pressurisation of pipe work and systems. Low pressure warnings are ignored during priming to allow the system to prime correctly, whilst a failsafe timeout prevents the pump from continuing to run in the event of a failure to prime. This helps to prevent the effects of water hammering (such as bursting water pipes) or damage to fountain / sprinkler heads.

The time limit, set for pump prime mode to complete, means that the pressure in the system must reach the minimum level within the set time. Failure of the system to pressurise would indicate a leak or burst pipe within the pump system and result in the Optidrive Eco Pump shutting down the pump. During normal operation the system pressure is still continuously monitored against the minimum level so that a burst pipe during normal operation will likewise result in the drive tripping 'low pressure' and shutting the pump down.

Independent pump
control system

Optiflow
Communications

← Feedback
signal

Total Control

A single 'Master' drive acts to control and monitor system operation. Control connections are made to this drive only, saving installation time and reducing costs.

Simple Connection

Additional drives connected on the system require a single RJ45 connection and basic commissioning, leading to time savings and simplified installation.

Flexible Solution

The system can operate with up to five pumps in any configuration, e.g. Jockey Pump / Duty / Assist / Standby. Duty pumps are automatically rotated, ensuring maximum service life and system efficiency.



See OPTIFLOW™ in action

Scan to watch the video or visit
<http://youtu.be/9QQ89bQYdfs>

Avoid Pump Downtime

Blockage Detect/Clear

Optidrive Eco Pump can detect pump blockages and trigger a programmed cleaning cycle to automatically clear them, preventing downtime.

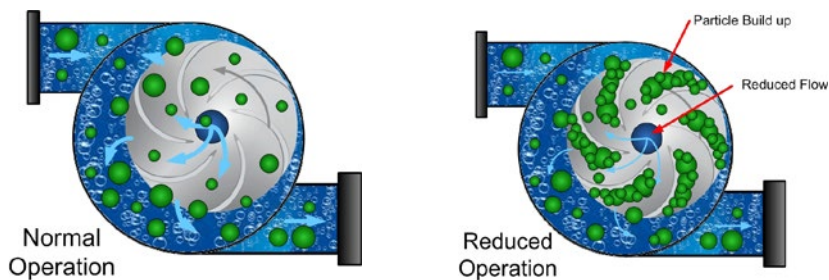

Dry Run Protection

Optidrive Eco Pump can evaluate a pump's speed/power and shut it off or warn when the pump starts to run dry, protecting it from heat/friction damage.

Motor Preheat Function

Optidrive Eco Pump features a motor preheat function to help ensure moisture is not permitted to collect on the motor in periods of inactivity and prior to motor start up. In addition, the motor preheat function can be used to keep condensation from developing on the motor as the motor cools down immediately following a stop. The feature is fully configurable, meaning the pump can be always available the instant it is required.

Pump Stir Cycle

Triggered by a settable period of inactivity, a configurable cleaning cycle can be run to clear sediment, ensuring the pump is ready to run when needed.

Summary

- All drives operate at variable speed for maximum energy efficiency.
- Operating time (Hours Run) is automatically balanced and duty pumps rotated
- Automatic system reconfiguration in the event of a pump fault (including the master pump).
- Continued system operation when drives are individually powered off (including the master drive).
- Communication and +24V control voltage shared between drives via a standard RJ45 patch lead.
- Independent maintenance indicators for each pump.
- Any pump can be switched to Hand operation a the touch of a button, and will automatically rejoin the network when switched back to Auto.
- For waste water applications each pump can be set for blockage/ragging detection and activate an automatic de-ragging/pump cleaning cycle.
- Optional mains isolator with lock-off for safe pump maintenance.
- Optiflow function configured through simple parameter set-up and intelligent drive self configuration.

Consistent Flow

The required pressure and flow levels are maintained regardless of how many pumps are required. When demand increases, additional pumps are automatically brought on stream to assist and are switched off again when not required.

Reduced Downtime

In the event of a fault, or if a pump needs to be isolated for maintenance, the system will automatically continue to operate with the remaining available pumps. The mains power can even be completely isolated from the Master drive without affecting operation of the Slave drives.

Drive Features

A compact and robust range of drives dedicated to pump control



Internal EMC Filter
Compliant with global EMC Standards

Maintenance interval timer and service indication

Multi Language Text Display

Hand / Auto Keypad

Pluggable terminals

Integrated cable management

Long Life, Dual Ball Bearing Fans

Enclosure Options

IP66 with optional mains disconnect

IP20 IP66 IP55

Multi Language Text Display

Installed as standard on all IP55 & IP66 models

- Clear multi-line text display
- Operates -10 to 50°C
- Wide viewing angle, effective in dark and light conditions
- Customisable display
- Multi-language selection





Energy efficient pumping with **OPTIFLOW™**



Noise Reduction

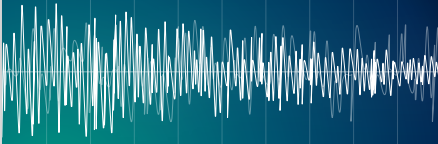

Quiet Motor Operation

High switching frequency selection (up to 32kHz) ensures motor noise is minimised.

Quiet System Mechanics

Simple skip frequency selection avoids stresses and noise caused by mechanical resonance in pipework.

Quiet Drive Operation

Long Life Dual Ball Bearing Fans provide quiet operation in addition to extended fan life.

Noise Reduction through Speed Control

Optimising motor speed gives significant energy savings and reduces motor noise.

Reduced Harmonic Current Distortion

Optidrive Eco Pump uses innovative design to improve overall efficiency whilst minimising the harmonic distortion levels. All drives designed for 3 phase power supply operation¹ up to frame size 5 utilise film capacitor in the DC link, providing exceptionally low harmonic current distortion without compromising efficiency. Frame size 6 and above include DC chokes and traditional electrolytic capacitors.

Optidrive Eco Pump product range complies with the requirements of EN61000-3-12.

Typical iTHD values at full and part load

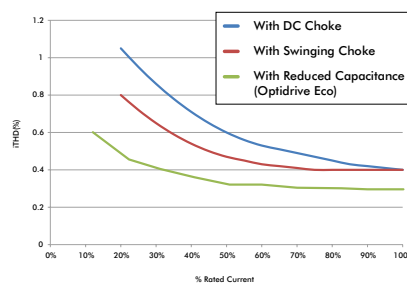

It can be clearly seen that the reduced DC link capacitance significantly reduces the total harmonic distortion at full load, and has a much greater benefit at part load compared to a conventional DC choke or swinging choke. This results in reduced overall input current and reduced transformer heating effect.

Optidrive Eco Pump delivers

- Improved Efficiency, Reduced Lifetime Costs: e.g. for a 37kW load, operating 10 hours per day, 5 days per week, 50 weeks per year, improving the efficiency by just 1% will provide an energy saving > 900kWh per year
- Improved True Power Factor – No additional charges etc.
- Lower Mains Supply Current

Power factor comparison

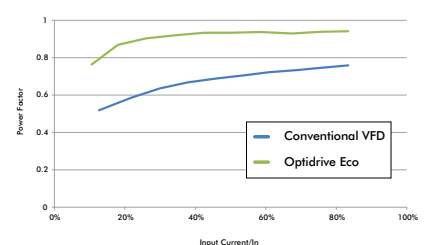

Optidrive Eco offers improved power factor over conventional VFDs under all loads.

¹ 200V and 400V

Options & Accessories

Peripherals to help integrate Optidrive Eco Pump with your pumping systems



Optistick Smart



NFC

Bluetooth®

Rapid Commissioning Tool

- Allows copying, backup and restore of drive parameters
- Provides Bluetooth interface to a PC running OptiTools Studio or the OptiTools Mobile app on a smartphone
- Onboard NFC (Near Field Communication) for rapid data transfer

OPT-3-STICK-IN

Optipad



Remote Keypad & TFT Display

IP55 panel mount operator interface.

- Clear multi-line text display
- Multiple language select
- Customisable displays

OPT-3-OPPAD-IN





Energy efficient pumping with **OPTIFLOW™**

OptiTools Studio

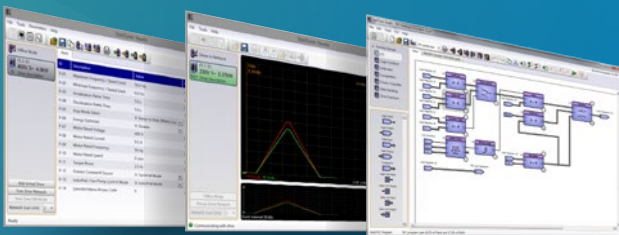

Powerful PC Software

Drive commissioning and parameter backup

- Real-time parameter editing
- Drive network communication
- Parameter upload, download and storage
- Simple PLC function programming
- Real-time scope function and data logging
- Real-time data monitoring

Compatible with:

- Windows Vista
- Windows 7
- Windows 8
- Windows 8.1
- Windows 10

Fieldbus Interfaces



BACnet/IP
OPT-2-BNTIP-IN



PROFIBUS DP
OPT-2-PROFB-IN



DeviceNet
OPT-2-DEVNT-IN



EtherNet/IP
OPT-2-ETHNT-IN



Modbus TCP
OPT-2-MODIP-IN



PROFINET
OPT-2-PFNET-IN



EtherCAT
OPT-2-ETCAT-IN



Plug-in Options



Extended I/O
OPT-2-EXTIO-IN

- Additional 3 Digital Inputs
- Additional Relay Output

Cascade Control

OPT-2-CASCD-IN
Additional 3 Relay Outputs

BACnet MS/TP & Modbus RTU
on board as standard

Mains Isolator



Mains Isolator Option

Frame Sizes 2 & 3 can be factory ordered with a built in lockable isolator. An optional bolt on isolator is available for Frame Sizes 4 & 5.

Product Codes:

Frame Size 4 = OPT-2-ISOL4-IN
Frame Size 5 = OPT-2-ISOL5-IN

Replace # in model code with enclosure/display option

	kW	HP	Amps	Frame Size	Model Code							IP20 Cabinet Mount	IP55 TFT Display	Indoor IP66 Non Switched	Indoor IP66 with Disconnect	Outdoor IP66 Non Switched	Outdoor IP66 with Disconnect	
					Product Family	Generation	Frame Size	Voltage Code	Output Rating	Supply Phases	EMC Filter							Qualification
200-240V ± 10% 1 Phase Input	0.75	1	4.3	2	ODV	-3	-2	2	0043	-1	F	1	#	2-MN	X-TN	D-TN	A-MN	E-MN
	1.5	2	7	2	ODV	-3	-2	2	0070	-1	F	1	#	2-MN	X-TN	D-TN	A-MN	E-MN
	2.2	3	10.5	2	ODV	-3	-2	2	0105	-1	F	1	#	2-MN	X-TN	D-TN	A-MN	E-MN
200-240V ± 10% 3 Phase Input	0.75	1	4.3	2	ODV	-3	-2	2	0043	-3	F	1	#	2-MN	X-TN	D-TN	A-MN	E-MN
	1.5	2	7	2	ODV	-3	-2	2	0070	-3	F	1	#	2-MN	X-TN	D-TN	A-MN	E-MN
	2.2	3	10.5	2	ODV	-3	-2	2	0105	-3	F	1	#	2-MN	X-TN	D-TN	A-MN	E-MN
	4	5	18	3	ODV	-3	-3	2	0180	-3	F	1	#	2-MN	X-TN	D-TN	A-MN	E-MN
	5.5	7.5	24	3	ODV	-3	-3	2	0240	-3	F	1	#	2-MN	X-TN	D-TN	A-MN	E-MN
	7.5	10	30	3	ODV	-3	-3	2	0300	-3	F	1	#	2-MN	X-TN	D-TN	A-MN	E-MN
	7.5	10	30	4	ODV	-3	-4	2	0300	-3	F	1	#	2-MN	N-MN			
	11	15	46	4	ODV	-3	-4	2	0460	-3	F	1	#	2-MN	N-MN		A-MN	E-MN
	15	20	61	5	ODV	-3	-5	2	0610	-3	F	1	#	2-MN	N-MN			
	18.5	25	72	5	ODV	-3	-5	2	0720	-3	F	1	#	2-MN	N-MN			
	22	30	90	5	ODV	-3	-5	2	0900	-3	F	1	#	2-MN	N-MN			
	30	40	110	6	ODV	-3	-6	2	1100	-3	F	1	#	2-MN	N-MN			
	30	40	110	6A	ODV	-3	-6	2	1100	-3	F	1	#	2-MN				
	37	50	150	6	ODV	-3	-6	2	1500	-3	F	1	#	2-MN	N-MN			
	37	50	150	6A	ODV	-3	-6	2	1500	-3	F	1	#	2-MN				
	45	60	180	6	ODV	-3	-6	2	1800	-3	F	1	#	2-MN	N-MN			
	45	60	180	6B	ODV	-3	-6	2	1800	-3	F	1	#	2-MN				
	55	75	202	7	ODV	-3	-7	2	2020	-3	F	1	#	2-MN	N-MN			
75	100	248	7	ODV	-3	-7	2	2480	-3	F	1	#	2-MN	N-MN				
380-480V ± 10% 3 Phase Input	0.75	1	2.2	2	ODV	-3	-2	4	0022	-3	F	1	#	2-MN	X-TN	D-TN	A-MN	E-MN
	1.5	2	4.1	2	ODV	-3	-2	4	0041	-3	F	1	#	2-MN	X-TN	D-TN	A-MN	E-MN
	2.2	3	5.8	2	ODV	-3	-2	4	0058	-3	F	1	#	2-MN	X-TN	D-TN	A-MN	E-MN
	4	5	9.5	2	ODV	-3	-2	4	0095	-3	F	1	#	2-MN	X-TN	D-TN	A-MN	E-MN
	5.5	7.5	14	2	ODV	-3	-2	4	0140	-3	F	1	#	2-MN			A-MN	E-MN
	5.5	7.5	14	3	ODV	-3	-3	4	0140	-3	F	1	#	2-MN	X-TN	D-TN		
	7.5	10	18	3	ODV	-3	-3	4	0180	-3	F	1	#	2-MN	X-TN	D-TN	A-MN	E-MN
	11	15	24	3	ODV	-3	-3	4	0240	-3	F	1	#	2-MN	X-TN	D-TN	A-MN	E-MN
	15	20	30	3	ODV	-3	-3	4	0300	-3	F	1	#	2-MN			A-MN	E-MN
	15	20	30	4	ODV	-3	-4	4	0300	-3	F	1	#	2-MN	N-MN			
	18.5	25	39	4	ODV	-3	-4	4	0390	-3	F	1	#	2-MN	N-MN		A-MN	E-MN
	22	30	46	4	ODV	-3	-4	4	0460	-3	F	1	#	2-MN	N-MN		A-MN	E-MN
	30	40	61	5	ODV	-3	-5	4	0610	-3	F	1	#	2-MN	N-MN			
	37	50	72	5	ODV	-3	-5	4	0720	-3	F	1	#	2-MN	N-MN			
	45	60	90	5	ODV	-3	-5	4	0900	-3	F	1	#	2-MN	N-MN			
	55	75	110	6	ODV	-3	-6	4	1100	-3	F	1	#	2-MN	N-MN			
	55	75	110	6A	ODV	-3	-6	4	1100	-3	F	1	#	2-MN				
	75	100	150	6	ODV	-3	-6	4	1500	-3	F	1	#	2-MN	N-MN			
	75	100	150	6A	ODV	-3	-6	4	1500	-3	F	1	#	2-MN				
	90	150	180	6	ODV	-3	-6	4	1800	-3	F	1	#	2-MN	N-MN			
90	150	180	6B	ODV	-3	-6	4	1800	-3	F	1	#	2-MN					
110	175	202	6B	ODV	-3	-6	4	2020	-3	F	1	#	2-MN					
110	175	202	7	ODV	-3	-7	4	2020	-3	F	1	#	2-MN	N-MN				
132	200	240	7	ODV	-3	-7	4	2400	-3	F	1	#	2-MN	N-MN				
160	250	302	7	ODV	-3	-7	4	3020	-3	F	1	#	2-MN	N-MN				
200	300	370	8	ODV	-3	-8	4	3700	-3	#	1	#	2-MN	N-MN				
250	350	480	8	ODV	-3	-8	4	4500	-3	#	1	#	2-MN	N-MN				
500-600V ± 10% 3 Phase Input	0.75	1	2.1	2	ODV	-3	-2	6	0021	-3	0	1	#	2-MN	X-TN	D-TN	A-MN	E-MN
	1.5	2	3.1	2	ODV	-3	-2	6	0031	-3	0	1	#	2-MN	X-TN	D-TN	A-MN	E-MN
	2.2	3	4.1	2	ODV	-3	-2	6	0041	-3	0	1	#	2-MN	X-TN	D-TN	A-MN	E-MN
	4	5	6.5	2	ODV	-3	-2	6	0065	-3	0	1	#	2-MN	X-TN	D-TN	A-MN	E-MN
	5.5	7.5	9	2	ODV	-3	-2	6	0090	-3	0	1	#	2-MN	X-TN	D-TN	A-MN	E-MN
	7.5	10	12	3	ODV	-3	-3	6	0120	-3	0	1	#	2-MN	X-TN	D-TN	A-MN	E-MN
	11	15	17	3	ODV	-3	-3	6	0170	-3	0	1	#	2-MN	X-TN	D-TN	A-MN	E-MN
	15	20	22	3	ODV	-3	-3	6	0220	-3	0	1	#	2-MN			A-MN	E-MN
	15	20	22	4	ODV	-3	-4	6	0220	-3	0	1	#	2-MN	N-MN			
	18.5	25	28	4	ODV	-3	-4	6	0280	-3	0	1	#	2-MN	N-MN		A-MN	E-MN
	22	30	34	4	ODV	-3	-4	6	0340	-3	0	1	#	2-MN	N-MN		A-MN	E-MN
	30	40	43	4	ODV	-3	-4	6	0430	-3	0	1	#	2-MN	N-MN		A-MN	E-MN
	37	50	54	5	ODV	-3	-5	6	0540	-3	0	1	#	2-MN	N-MN			
	45	60	65	5	ODV	-3	-5	6	0650	-3	0	1	#	2-MN	N-MN			
	55	75	78	6	ODV	-3	-6	6	0780	-3	0	1	#	2-MN	N-MN			
	75	100	105	6	ODV	-3	-6	6	1050	-3	0	1	#	2-MN	N-MN			
	90	125	130	6	ODV	-3	-6	6	1300	-3	0	1	#	2-MN	N-MN			
	110	150	150	6	ODV	-3	-6	6	1500	-3	0	1	#	2-MN	N-MN			

EMC Filter

- 0** No Internal EMC Filter
- F** Internal EMC Filter
- R** High Performance EMC Filter

Drive Specification

Input Ratings	Supply Voltage	200 – 240V ± 10% 380 – 480V ± 10% 500 – 600V ± 10%
	Supply Frequency	48 – 62Hz
	Displacement Power Factor	> 0.98
	Phase Imbalance	3% Maximum allowed
	Inrush Current	< rated current
	Power Cycles	120 per hour maximum, evenly spaced
	Output Ratings	Output Power
Overload Capacity		110% for 60 seconds 165% for 4 seconds
Output Frequency		0 – 250Hz, 0.1Hz resolution
Typical Efficiency		> 98%
Ambient Conditions		Temperature: Storage: –40 to 60°C Operating: –10 to 50°C Altitude: Up to 1000m ASL without derating Up to 2000m maximum UL approved Up to 4000m maximum (non UL) Humidity: 95% Max, non condensing Vibration: Conforms to EN61800-5-1 2007, IEC 60068-2-6
Enclosure	Ingress Protection	IP20, IP55, IP66
	Programming	Keypad: Built-in keypad as standard Optional remote mountable keypad Display: Built-in multi language text display PC: OptiTools Studio
Control Specification	Control Method	Eco Sensorless Vector Open Loop Permanent Magnet Vector Open Loop BLDC Vector Open Loop Synchronous Reluctance Vector
	PWM Frequency	4 – 32kHz Effective
	Stopping Mode	Ramp to stop: User Adjustable 0.1–600 secs Coast to stop
	Braking	AC Flux Braking
Setpoint Control	Analog Signal	0 to 10 Volts / 10 to 0 Volts –10 Volts to +10 Volts 0 to 20mA / 20 to 0mA 4 to 20mA / 20 to 4mA
		Digital
	Fieldbus Connectivity	Built-in
Optional	BACnet/IP	Plug-in BACnet/IP interface Dual IAN ports Device Level Ring
	Other	PROFIBUS DP (DPV1) PROFINET IO DeviceNet EtherNet/IP EtherCAT Modbus TCP

I/O Specification	Power Supply	24 Volt DC, 100mA, Short Circuit Protected 10 Volt DC, 10mA for Potentiometer	
	Programmable Inputs	5 Total as standard (optional additional 3) 3 Digital (optional additional 3) 2 Analog / Digital selectable	
	Digital Inputs	Opto - Isolated 8 – 30 Volt DC, internal or external supply Response time < 4ms	
	Analog Inputs	Resolution: 12 bits Response time: < 4ms Accuracy: < 1% full scale Parameter adjustable scaling and offset	
	PTC Input	Motor PTC / Thermistor Input Trip Level : 3kΩ	
	Programmable Outputs	2 Total 1 Analog / Digital 1 Relay	
	Relay Outputs	Maximum Voltage: 250 VAC, 30 VDC Switching Current Capacity: 5A	
	Analog Outputs	0 to 10 Volts / 10 to 0 Volts 0 to 20mA / 20 to 0mA 4 to 20mA / 20 to 4mA	
	Application Features	PID Control	Internal PID Controller Multi-setpoint Select Standby / Sleep Mode Boost Function
		Fire Mode	Bi-directional Selectable Speed Setpoint (Fixed / PID / Analog / Fieldbus)
Load Monitoring		High Current Protection (Fan / Bump Blocked) Low Current Protection (Broken Belt / Shaft) Pump Blockage Detection with Cleaning	
Duty / Assist / Standby		Built-in Multi-Pump Support Automatic Changeover on Fault Automatic Changeover on Time Fully Redundant	
Pump Control Features	Pump Blockage Detection	Pump load monitoring with autotune function, user configurable	
	Pump Cleaning	Adjustable Bi-directional Pump Cleaning Cycle operation	
	Multi-Pump Control	Control of fixed speed assist pumps (with cascade control module) Control of Duty, Assist and Standby variable speed pumps via internal Master – Slave network	
	Pump Stir	Automatic pump stir to prevent sediment build-up	
Maintenance & Diagnostics	Fault Memory	Last 4 Trips stored with time stamp	
	Data Logging	Logging of data prior to trip for diagnostic purposes: Output Current Drive Temperature DC Bus Voltage	
	Maintenance Indicator	Maintenance Indicator with user adjustable maintenance interval Onboard service life monitoring	
	Monitoring	Hours Run Meter Resettable & Non-Resettable kWh meters Cooling Fan Run Time	
Standards Compliance	Low Voltage Directive	2014/35/EU	
	EMC Directive	2014/30/EU	
	Additional Conformance	UL, cUL, EAC, RCM	
	Harmonic Currents	IEC61000-3-12	
Environmental Conditions	Designed to meet IEC 60721-3-3, in operation: IP20 Drives: 3S2/3C2 IP55 & 66 Drives: 3S3/3C3		

Model Code Guide

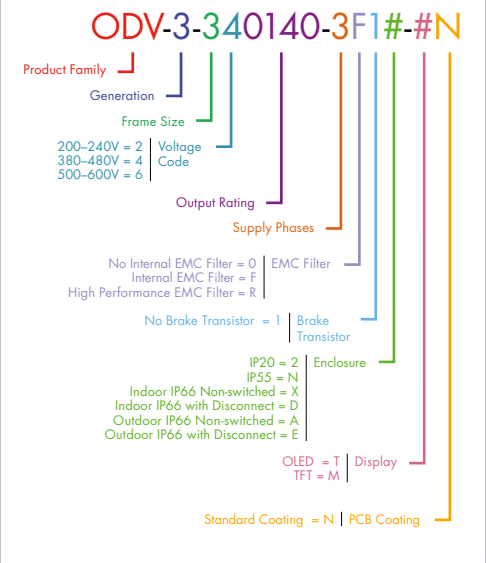

Connection Diagram

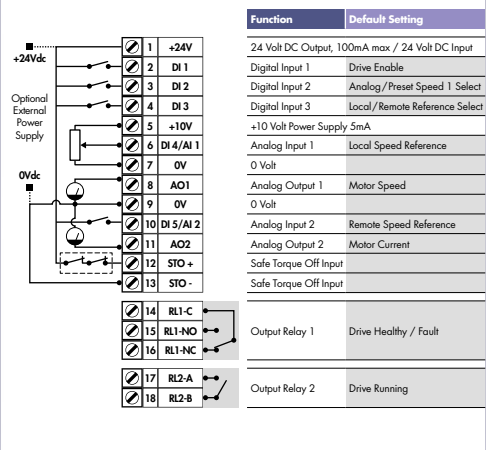

NOT TO SCALE

Size	IP20							IP66			IP55				
	2	3	4	5	6A	6B	8	2	3	4	4	5	6	7	8
mm Height	221	261	418	486	614	726	974	257	310	360	450	540	865	1280	1334
mm Width	110	131	172	233	286	330	444	188	211	240	171	235	330	330	444
mm Depth	185	205	240	260	320	320	423	182	235	271	252	270	332	358	423
kg Weight	1.8	3.5	9.2	18.1	32	43	124.5	3.5	6.6	9.5	11.5	23	55	89	TBC

Optidrive Eco Pump

✓ Saving Energy / Reducing CO₂

With large scale increases in global energy costs and the introduction of taxes and legislation relating to the industrial production of CO₂ gases the need to reduce energy consumption and save money has never been greater. Optidrive Eco Pump can be used with environmental sensors to reduce pump speed in pumping applications without compromising the required output of the system.

✓ Easy Installation

Compact and modern design utilising the latest available technology have accumulated in a robust Eco Pump drive with small dimensions and innovative mounting and cabling features.

✓ Simple Set-up & Rapid Commissioning

Optidrive Eco Pump was developed from concept for ease of use. A handful of parameters configure the drive for basic pump applications. A short, concise product data means the drive is running in seconds. Advanced powerful functionality is equally easily accessible.

✓ Imaginative Enclosure Design

With a selection of IP55 and IP66 enclosures, Optidrive Eco Pump is well suited to harsh environments, or where cabinet and cabling costs need to be reduced.

✓ Advanced Pump Control Functions

The key pump control functionality required for your application is inbuilt into Optidrive Eco Pump and packaged to be both quick and simple to activate. Added to this is the drive's own PLC programming flexibility that makes drive functionality virtually limitless.

✓ Options for Flexibility

Optidrive Eco Pump combines both peripheral and factory built options to ensure you get the right drive, scaled to suit your application. With inbuilt BACnet and Modbus, and a host of communication options the Optidrive can integrate easily into your industrial network of choice.



UK Headquarters, Welshpool

Invertek Drives Ltd is dedicated to the design, manufacture and marketing of electronic variable speed drives. The state of the art UK headquarters houses specialist facilities for research & development, manufacturing and global marketing. The company pledges to implement and operate the ISO 14001 Environmental Management System to enhance environmental performance.

All company operations are accredited to the exacting customer focused ISO 9001:2008 quality standard. The company's products are sold globally in over 80 different countries. Invertek Drives' unique and innovative drives are designed for ease of use and meet with recognised international design standards.

Global Pump Solutions

Invertek Drives operate at the heart of pumping systems around the world



IRELAND
Maintaining pressure at pumping stations



HOLLAND
Hot water pumping across district network



ITALY
Cooling loop flow & temperature control



AUSTRALIA
Improved reliability & running costs



www.invertekdrives.com/pump-control

INVERTEK DRIVES LIMITED UK Headquarters

Offa's Dyke Business Park
Welshpool, Powys, UK
SY21 8JF

Tel: +44 (0)1938 556868
Fax: +44 (0)1938 556869
Email: sales@invertekdrives.com

